



**UNIRAC<sup>®</sup>**

---

**PRODUCT CATALOG**

## PITCHED ROOF

### NXT UMount | OPEN CHANNEL RAIL-BASED MOUNTING SYSTEM

ALL System Components Page 1

### SOLARMOUNT | RAIL-BASED MOUNTING SYSTEM

SOLARMOUNT Rail & Splice Page 2

Rail Clamps - UNIVERSAL AF, PRO SERIES & Standard SM Page 3

Roof Attachments - SM BUTYL, FLASHLOC, FLASHKIT PRO, and FLASHKIT Tile Replacement Page 4

Roof Attachments - SOLARHOOKS, 2-Piece AI Standoffs, Metal Roof Attachments Page 5

SM Adjustable Tilt Legs & L-Foot, Grounding & Wire Management, Optional Trim & Rail Caps Page 6

Spare Hardware Page 7

### SFM INFINITY | RAIL-LESS MOUNTING SYSTEM

Microrail & Splices, Trim Components, COMP Shingle Roof Attachments Page 8

TILE Roof Attachments, MLPE Mounts, Wire Management, Hex Tool Page 9

### METAL X | METAL ROOF RAIL-LESS MOUNTING SYSTEM

Clamps, Couplings, Hardware Page 10

Metal Roof Attachments, MLPE Mounts, Wire Management Clips, Row-to-Row Bonding Page 11

## FLAT ROOF

### RM10 EVO | SOUTH FACING 10 DEGREE TILT MOUNTING SYSTEM

ALL System Components Page 12

### GRIDFLEX™ | BUILT FOR SPEED FLAT ROOF SYSTEM

ALL System Components Page 13

### RM5 | SOUTH FACING 5 DEGREE TILT MOUNTING SYSTEM

ALL System Components Page 14

### RMDT | 8 DEGREE EAST-WEST TILT MOUNTING SYSTEM

ALL System Components Page 15

### ECOFOOT2+ | UNIVERSAL BALLASTED MOUNTING SYSTEM

ALL System Components Page 16

### ECOFOOT5D | HIGH DENSITY 5 DEGREE MOUNTING SYSTEM

ALL System Components Page 17

## GROUND MOUNT

### GROUND FIXED TILT (GFT) | GROUND MOUNT SYSTEM

ALL System Components Page 18

### UNIRAC LARGE ARRAY | GROUND MOUNT SYSTEM

ALL System Components Page 19

## E-BOSS

Conduit Mounts, SOLARTRAY Wire Management, SOLOBOX, MLPE Mounts Page 20



**NXT UMount® RAIL SYSTEM**

### NXT UMount RAIL & SPLICE

P/N	DESCRIPTION	PACK SIZE	SHIP WT. LBS
168RLD1	NXT UMount RAIL - 168" DARK	168	1000.00
168RLM1	NXT UMount RAIL - 168" MILL	168	1000.00
RLSPLCM2	NXT UMount RAIL SPLICE	20	2.00



**NXT UMount® COMBO CLAMP**

### NXT UMount MODULE CLAMPS

P/N	DESCRIPTION	PACK SIZE	SHIP WT. LBS
CCLAMPD1	NXT UMount COMBO CLAMP - DARK	20	37.00
CCLAMPM1	NXT UMount COMBO CLAMP - MILL	20	37.00
NUHECLMP1	NXT HIDDEN END CLAMP W/ CAP	4	2.00

### STRONGHOLD ATTACHMENTS

P/N	DESCRIPTION	PACK SIZE	SHIP WT. LBS
SHBUTYLD2	STRONGHOLD BUTYL ATT KIT #14S DARK	20	11.50
SHBUTYLM2	STRONGHOLD BUTYL ATT KIT #14S MILL	20	11.50
XTRABUTL-SH	EXTRA BUTYL PAD - SH, KIT	30	
SHCPKTD1	STRONGHOLD ATT KIT COMP DRK	20	13.00
SHCPKTM1	STRONGHOLD ATT KIT COMP MILL	20	13.00
SHCLMPD1	STRONGHOLD RAIL CLAMP DRK	20	4.00
SHCLMPM1	STRONGHOLD RAIL CLAMP MILL	20	4.00



**STRONGHOLD™ ATTACHMENT KIT**

### WIRE MANAGEMENT & ACCESSORIES

P/N	DESCRIPTION	PACK SIZE	SHIP WT. LBS
LUGMLPE1	NXT UMount MLPE & LUG CLAMP	20	20.00
WRMCNSD1	NXT UMount NS WIRE MGMT CLIP	20	13.00
ENDCAPD1	NXT UMount RL & CLMP CAP KIT	20	5.00
WRMCLPD1	NXT UMount WIRE MGMT CLIP	20	1.00

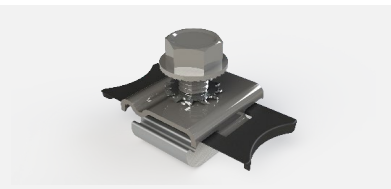

**NXT UMount® MLPE & LUG CLAMP**

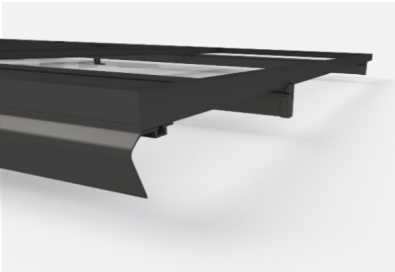

**SOLARMOUNT® RAIL SYSTEM**

### SOLARMOUNT LIGHT RAILS - DISTRIBUTOR PACK

P/N	DESCRIPTION	PACK SIZE	SHIP WT. LBS
315168D	SM LIGHT RAIL 168" DRK	144	990.72
315168M	SM LIGHT RAIL 168" MILL	144	990.72
315208D	SM LIGHT RAIL 208" DRK	144	1226.61
315208M	SM LIGHT RAIL 208" MILL	144	1226.61
315246D	SM LIGHT RAIL 246" DRK	144	1452.38
315246M	SM LIGHT RAIL 246" MILL	144	1452.38

### SOLARMOUNT STANDARD RAILS - DISTRIBUTOR PACK

P/N	DESCRIPTION	PACK SIZE	SHIP WT. LBS
320132M	SM RAIL 132" MILL	144	1188.00
310132C	SM RAIL 132" CLR	144	1188.00
320168M	SM RAIL 168" MILL	144	1512.00
310168D	SM RAIL 168" DRK	144	1512.00
310168C	SM RAIL 168" CLR	144	1512.00
320208M	SM RAIL 208" MILL	144	1872.00
310208C	SM RAIL 208" CLR	144	1872.00
320246M	SM RAIL 246" MILL	144	2214.00
310246D	SM RAIL 246" DRK	144	2214.00
310246C	SM RAIL 246" CLR	144	2214.00

### SOLARMOUNT STANDARD RAILS - PRO-PAK BUNDLE OF 8 RAILS

P/N	DESCRIPTION	PACK SIZE	SHIP WT. LBS
320132M-B	SM RAIL 132" MILL 8PK	8	66.00
310132C-B	SM RAIL 132" CLR 8PK	8	66.00
320168M-B	SM RAIL 168" MILL 8 PK	8	84.00
310168D-B	SM RAIL 168" DARK 8PK	8	84.00
310168C-B	SM RAIL 168" CLR 8PK	8	84.00
320208M-B	SM RAIL 208" MILL 8 PK	8	104.00
310208C-B	SM RAIL 208" CLR 8PK	8	104.00
320246M-B	SM RAIL 246" MILL 8 PK	8	123.00
310246C-B	SM RAIL 246" CLR 8PK	8	123.00

### SOLARMOUNT RAIL SPLICE

P/N	DESCRIPTION	PACK SIZE	SHIP WT. LBS
303019D	BND SPLICE BAR PRO SERIES DRK	20	9.00
303019M	BND SPLICE BAR PRO SERIES MILL	20	9.00

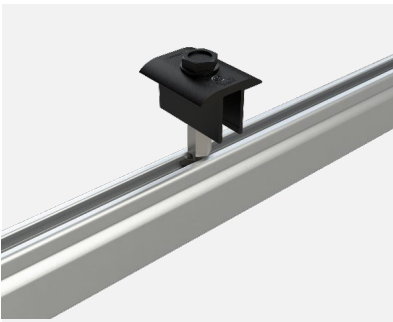

**UNIVERSAL AF MID CLAMP**



**UNIVERSAL AF END CLAMP**

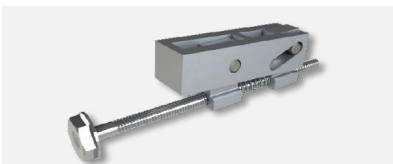

**PRO SERIES HIDDEN END CLAMP**

**UNIVERSAL AESTHETIC FASTENER (AF) MODULE CLAMPS**

P/N	DESCRIPTION	PACK SIZE	SHIP WT. LBS
302045D	UNIVERSAL AF MID CLAMP DRK	20	2.20
302045M	UNIVERSAL AF MID CLAMP MILL	20	2.20
302050D	UNIVERSAL AF END CLAMP DRK	20	2.95
302050M	UNIVERSAL AF END CLAMP MILL	20	2.95

**PRO SERIES MODULE CLAMPS**

P/N	DESCRIPTION	PACK SIZE	SHIP WT. LBS
302030D	SM MIDCLAMP PRO DRK	20	2.20
302030M	SM MIDCLAMP PRO MILL	20	2.20
302035M	SM ENDCLAMP PRO W/CAP	4	0.60

**SOLARMOUNT STANDARD MODULE CLAMPS**

P/N	DESCRIPTION	PACK SIZE	SHIP WT. LBS
302027D	SM BND MIDCLAMP BC DRK SS	20	2.00
302027C	SM BND MIDCLAMP BC SS	20	2.00
302029D	SM BND MIDCLAMP DK DRK SS	20	2.00
302029C	SM BND MIDCLAMP DK SS	20	2.00
302028D	SM BND MIDCLAMP EF DRK SS	20	2.00
302028C	SM BND MIDCLAMP EF SS	20	2.00
302021C	SM ENDCLAMP B CLR AL	20	2.00
302021D	SM ENDCLAMP B DRK AL	20	2.00
302022C	SM ENDCLAMP C CLR AL	20	2.00
302022D	SM ENDCLAMP C DRK AL	20	2.00
302023C	SM ENDCLAMP D CLR AL	20	2.00
302023D	SM ENDCLAMP D DRK AL	20	2.00
302024C	SM ENDCLAMP E CLR AL	20	2.00
302024D	SM ENDCLAMP E DRK AL	20	2.00
302025C	SM ENDCLAMP F CLR AL	20	2.00
302025D	SM ENDCLAMP F DRK AL	20	2.00
302026C	SM ENDCLAMP K CLR AL	20	2.00
302026D	SM ENDCLAMP K DRK AL	20	2.00

**SM STANDARD CLAMP HEIGHT & BOLT LENGTH**

LETTER	MODULE THICKNESS	BOLT LG
B	30MM - 32MM	1.18IN - 1.26IN
C	33MM - 36MM	1.30IN - 1.42IN
D	38MM - 40MM	1.50IN - 1.57IN
K	39MM - 41MM	1.54IN - 1.61IN
F	45MM - 47MM	1.77IN - 1.85IN
E	50MM - 51MM	1.97IN - 2.00IN

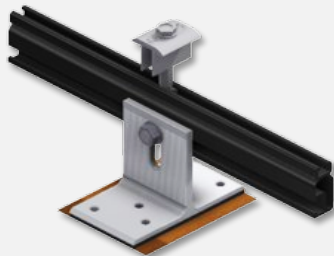

**SOLARMOUNT BUTYL ATTACHMENT**

**SOLARMOUNT BUTYL ATTACHMENTS**

P/N	DESCRIPTION	PACK SIZE	SHIP WT. LBS
004BUTYLD	SM DTD ATT W/ BUTYL, DARK	20	
004BUTYLM	SM DTD ATT W/ BUTYL, MILL	20	
003251W	DTD #14 3IN SELF-DRILL SCREW	80	

**FLASHLOC ATTACHMENTS**

P/N	DESCRIPTION	PACK SIZE	SHIP WT. LBS
004085D	FLASHLOC COMP KIT DRK	20	10.00
004085M	FLASHLOC COMP KIT MILL	20	10.00
004275D	FLASHLOC DUO DARK	20	10.00
004275M	FLASHLOC DUO MILL	20	10.00
003250W	#12-14 X 2.50 SCREW HDW SS SD	80	



**FLASHLOC™ DUO**

**FLASHKIT PRO & SWITCHBLADE (SB) ATTACHMENTS**

P/N	DESCRIPTION	PACK SIZE	SHIP WT. LBS
004055D	FLASHKIT PRO, DRK 10PK	10	7.35
004055M	FLASHKIT PRO, MILL 10PK	10	7.35
004015D	FLASHKIT SB, DARK	10	5.50
004015M	FLASHKIT SB, MILL	10	5.50

**FLASHKIT TILE REPLACEMENT TILE ROOF ATTACHMENTS**

P/N	DESCRIPTION	PACK SIZE	SHIP WT. LBS
004TRFA	FLASHKIT TR FLAT-TILE ADOBE	10	30.00
004TRFD	FLASHKIT TR FLAT-TILE CHARCOAL	10	30.00
004TRFM	FLASHKIT TR FLAT-TILE MILL	10	30.00
004TRSA	FLASHKIT TR SPAN-TILE ADOBE	10	31.00
004TRSD	FLASHKIT TR SPAN-TILE CHARCOAL	10	31.00
004TRSM	FLASHKIT TR SPAN-TILE MILL	10	31.00
004TRWA	FLASHKIT TR W-TILE ADOBE	10	31.00
004TRWD	FLASHKIT TR W-TILE CHARCOAL	10	31.00
004TRWM	FLASHKIT TR W-TILE MILL	10	31.00
004TRSF	TR UNIV SUB-FLASHING	50	10.00

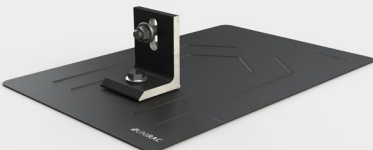

**FLASHKIT PRO**



**UNIRAC PRO SERIES SOLARHOOKS**

### SOLARHOOK TILE ROOF ATTACHMENTS

P/N	DESCRIPTION	PACK SIZE	SHIP WT. LBS
004CT5H	SOLARHOOK UNIVERSAL	30	46.00
004CT1H	SOLARHOOK SPANISH 7" BASE	20	26.00
004CT2H	SOLARHOOK SPANISH 9" BASE	20	30.00
004AT1H	SOLARHOOK FLAT TILE	30	32.00
004FLCT	SOLARHOOK FLASHING SPANISH FLCT	30	16.50
004FLAT	SOLARHOOK FLASHING FLAT	30	16.50
004AST1	SOLARHOOK ADJ STONE COATED ST1	30	32.00
004ST1S	SOLARHOOK STONE COATED MT ST1	30	55.00
035014C	HDW LAG BOLT, 1/4 X 3-1/2 SS	60	2.50

### SOLARHOOK TILE FLASHINGS

P/N	DESCRIPTION	PACK SIZE	SHIP WT. LBS
004TFFM	TILE FLASHING FLAT MILL	30	
004TFSM	TILE FLASHING SPANISH MILL	30	
004TFWM	TILE FLASHING W MILL	30	



**TWO-PIECE ALUMINUM STANDOFF**

### TWO-PIECE ALUMINUM STANDOFF ROOF ATTACHMENTS

P/N	DESCRIPTION	PACK SIZE	SHIP WT. LBS
004300D	STANDOFF 3" 2 PIECE AL, DRK	24	15.00
004300M	STANDOFF 3" 2 PIECE AL, MILL	24	15.00
004400D	STANDOFF 4" 2 PIECE AL, DRK	24	17.00
004400M	STANDOFF 4" 2 PIECE AL, MILL	24	17.00
004600D	STANDOFF 6" 2 PIECE AL, DRK	24	21.00
004600M	STANDOFF 6" 2 PIECE AL, MILL	24	21.00
004700D	STANDOFF 7" 2 PIECE AL, DRK	24	22.00
004700M	STANDOFF 7" 2 PIECE AL, MILL	24	23.00
330007M	3/8 BOLT/WASHER TO AL STANDOFF	24	1.00
004013C	FLASH SOFT AL 18X18 OATEY12836	12	11.00

### METAL ROOF ATTACHMENTS

P/N	DESCRIPTION	PACK SIZE	SHIP WT. LBS
004130M	STANDING SEAM CLAMP, MINI 1SS	50	25.20
004131M	STANDING SEAM CLAMP, STAND 2SS	50	27.80
004132M	STANDING SEAM CLAMP, WIDE 2SS	50	30.30
004257M	R-PANEL METAL ROOF MNT, 9000-S	50	24.10
004259M	R-PANEL POWERMOUNT ADJUST	50	

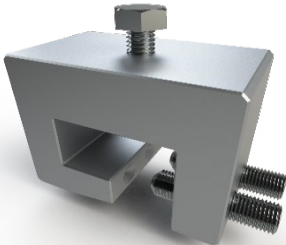

**METAL ROOF ATTACHMENT**

## SOLARMOUNT ADJUSTABLE TILT LEGS & L-FEET

P/N	DESCRIPTION	PACK SIZE	SHIP WT. LBS
307107M	SM ADJ TILT LEG, 12°, W/HDW	20	2.00
307115M	SM ADJ TILT LEG, 30°, W/HDW	4	3.00
307120M	SM ADJ TILT LEG, 44°, W/HDW	1	4.00
307134M	SM ADJ TILT LEG, 72°, W/HDW	1	5.00
304001C	L-FOOT SERRATED W/ T-BOLT, CLR	20	5.00
304001D	L-FOOT SERRATED W/ T-BOLT, DRK	20	5.00

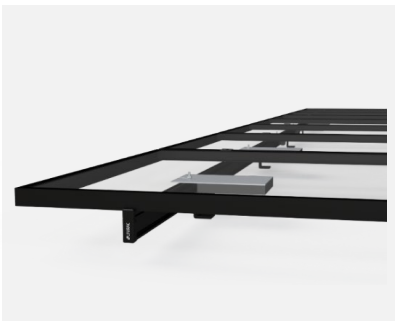

## GROUNDING, BONDING, WIRE MANAGEMENT

### SOLARMOUNT INTEGRATED BONDING MLPE MOUNT

P/N	DESCRIPTION	PACK SIZE	SHIP WT. LBS
008013S	MICRO MNT BND TBOLT 1/4X3/4 SS	100	2.00

### SOLARMOUNT GROUNDING & BONDING HARDWARE

P/N	DESCRIPTION	PACK SIZE	SHIP WT. LBS
008002S	GROUND WEEBLUG #1	20	2.00
008009P	ILSCO LAY IN LUG	20	2.00
008015S	WIRE BND CLIP	10	1.00

### SOLARMOUNT WIRE MANAGEMENT CLIPS

P/N	DESCRIPTION	PACK SIZE	SHIP WT. LBS
008003S	ONE WIRE CLIP, SS, DCS 1306	500	3.00
008004S	TWO WIRE CLIP, SS, DCS 1307	500	3.00
008017S	HEYCO SUNRUNNER 2-S CLIP 100/B	500	7.00
008018S	HEYCO SUNRUNNER 4-2U CLIP 100/B	500	6.00
008019S	HEYCO SUNRUNNER CLIP 100/B	100	7.00
008020S	HEYCO SUNRUNNER 4 CLIP 100/B	100	7.00

## OPTIONAL FRONT TRIM & RAIL END CAP

### SOLARMOUNT TRIM

P/N	DESCRIPTION	PACK SIZE	SHIP WT. LBS
206072D-B	SM TRIM 168" DRK 8PK	8	75.28
008025S	SM TRIM END CLIP	10	0.10

### SOLARMOUNT RAIL END CAP

P/N	DESCRIPTION	PACK SIZE	SHIP WT. LBS
309003P	SM RAIL END CAP, PRO UV-BLK	100	1.00



## SOLARMOUNT SPARE HARDWARE

P/N	DESCRIPTION	PACK SIZE	SHIP WT. LBS
009021S	BND T-BOLT&NUT 3/8" X 1" SS	20	1.00
009020S	BND T-BOLT&NUT 3/8" X 3/4" SS	20	2.00
030027C	HDW LAG BOLT, 5/16 X 4	50	4.00
030028C	HDW LAG BOLT, 5/16 X 4.5	50	4.00
330050D	BND T-BOLT&NUT 1/4"X2" DRK SS	20	1.00
330050S	BND T-BOLT&NUT 1/4"X2" SS	20	1.00
330051D	BND T-BOLT&NUT 1/4"X2.25"DRKSS	20	1.00
330051S	BND T-BOLT&NUT 1/4"X2.25" SS	20	1.00
330052D	BND T-BOLT&NUT 1/4"X2.5" DRKSS	20	1.00
330052S	BND T-BOLT&NUT 1/4"X2.5" SS	20	1.00



**SFM INFINITY® RAIL-LESS SYSTEM**

### SFM INFINITY MICRORAILS & SPLICES

P/N	DESCRIPTION	PACK SIZE	SHIP WT. LBS
250010U	SFM SPLICE 6.5"	10	10.00
250020U	SFM MICRORAIL 2"	10	6.25
250030U	SFM ATTACHED SPLICE 8"	10	15.00
253010U	SFM SPLICE 6.5" 30MM	10	10.00
253020U	SFM MICRORAIL 2" 30MM	10	6.25
253030U	SFM ATTACHED SPLICE 8" 30MM	10	15.00
008000U	SFM N/S BONDING CLAMP	20	3.00



**SFM BUTYL ATTACHMENT**

### SFM INFINITY STRUCTURAL TRIM COMPONENTS

P/N	DESCRIPTION	PACK SIZE	SHIP WT. LBS
256072U	SFM TRIMRAIL 72" UNIV DRK	4	22.46
250111U	SFM TRIMRAIL UNIV CLIP W/HDW	10	3.00
250120U	SFM TRIM SPLICE DRK	10	8.00
250130U	SFM TRIM END CAPS	10	0.50
008100U	SFM TRIM BONDING CLAMP	10	1.00
009040S	SFM TRINUT KIT	100	8.00

### SFM INFINITY ADHESIVE FLASHING ROOF ATTACHMENTS

P/N	DESCRIPTION	PACK SIZE	SHIP WT. LBS
SFMBTLM1	SFM DTD BUTYL ATT, MILL	20	
003251W	DTD #14 3IN SELF-DRILL SCREW	80	
004095D	FLASHLOC SFM TRIM KIT W/ CAP	20	
004285M	FLASHLOC SFM COMP MILL	20	



**SFM FLASHKIT PRO ATTACHMENT**

### SFM INFINITY FLASHKIT PRO COMP SHINGLE ROOF ATTACHMENTS

P/N	DESCRIPTION	PACK SIZE	SHIP WT. LBS
004200D	FLASHKIT SFM TRIM COMP DARK	10	10.00
004201D	FLASHKIT SFM TRIM S COMP DARK	10	7.00
004270D	FLASHKIT SFM SLIDER COMP DARK	10	9.00
004271D	FLASHKIT SFM SLIDER S COMP DARK	10	7.00
004080D	FLASHKIT SFM NRE COMP DARK	5	8.00
030040C	STRUCTURAL SCREW 5/16 X 4 SS	50	3.50
030045C	STRUCTURAL SCREW 5/16 X 4.5 SS	50	3.00

### SFM INFINITY TILE ROOF ATTACHMENTS

P/N	DESCRIPTION	PACK SIZE	SHIP WT. LBS
005TRFA	FLASHKIT SFMTR F ADOBE (1/2)	10	26.00
005TRFD	FLASHKIT SFMTR F CHARCL (1/2)	10	26.00
005TRFM	FLASHKIT SFMTR F MILL (1/2)	10	26.00
005TRSA	FLASHKIT SFMTR S ADOBE (1/2)	10	27.00
005TRSD	FLASHKIT SFMTR S CHARCL (1/2)	10	27.00
005TRSM	FLASHKIT SFMTR S MILL (1/2)	10	27.00
005TRWA	FLASHKIT SFMTR W ADOBE (1/2)	10	26.00
005TRWD	FLASHKIT SFMTR W CHARCL (1/2)	10	26.00
005TRWM	FLASHKIT SFMTR W MILL (1/2)	10	26.00
00520TR	FLASHKIT SFMTR TRIM ATT (2/2)	10	8.00
00527TR	FLASHKIT SFMTR SLIDER (2/2)	10	7.00
004TRSF	TR UNIV SUB-FLASHING	50	10.00

### SFM INFINITY MLPE MOUNT

P/N	DESCRIPTION	PACK SIZE	SHIP WT. LBS
008114M	MLPE MOUNT ASSY	10	1.00

### SFM INFINITY WIRE MANAGEMENT CLIPS

P/N	DESCRIPTION	PACK SIZE	SHIP WT. LBS
008003S	ONE WIRE CLIP, SS, DCS 1306	500	3.00
008004S	TWO WIRE CLIP, SS, DCS 1307	500	3.00
008017S	HEYCO SUNRUNNER 2-S CLIP 100/B	500	7.00
008018S	HEYCO SUNRUNNER 4-2U CLIP 100/B	500	6.00
008019S	HEYCO SUNRUNNER CLIP 100/B	100	7.00
008020S	HEYCO SUNRUNNER 4 CLIP 100/B	100	7.00
205000S	ENPHASE ENGAGE CABLE CLIP	100	4.00

### SFM INFINITY HEX TOOL

P/N	DESCRIPTION	PACK SIZE	SHIP WT. LBS
009030S	UNIRAC 1/4" HEX TOOL	10	1.00



**SFM MLPE MOUNT**

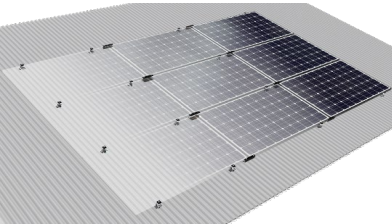

**METAL X® RAIL-LESS SYSTEM**



**CORRUGATED - XCLAMP + S-5  
CORRUBRACKET 100T**



**R-PANEL - XCLAMP + POWERMOUNT**



**STANDING SEAM - XCLAMP**

### METAL X CLAMPS & COUPLINGS

P/N	DESCRIPTION	PACK SIZE	SHIP WT. LBS
ES10828	METALX END CLAMP	108	24.00
ES10829	METALX MID CLAMP	108	31.00
ES10835	METALX END 30 CLAMP	108	23.00
ES10836	METALX MID 30 CLAMP	108	30.00
ES10368	METALX COUPLING	24	28.00
ES10146	METALX END COUPLING	24	16.00
ES10616	METALX UNI COUPLING	24	23.00
ES10619	METALX UNI CLAMP	48	25.00
ES10924	METALX COUPLING 30MM	24	
ES10261	METALX SERVICE NUT	500	30.00

### METAL X CLAMP HARDWARE

P/N	DESCRIPTION	PACK SIZE	SHIP WT. LBS
ES10079	BOLT, SERR FLNG BLK, 5/16X2.5	100	0.00
ES10085	BOLT, SERR FLNG BLK, 5/16X2	100	0.00
ES10271	BOLT, SERR FLNG BLK, 5/16X3	100	5.00
ES10325	5/16-18 SERR FLNG HEX NUT	100	2.00
ES10889	BOLT, CAP HEX, M8 X 55	200	12.00
ES10890	BOLT, CAP HEX, M8 X 60	200	12.00
ES10891	BOLT, CAP HEX, M8 X 65	200	12.00
ES10892	BOLT, CAP HEX, M8 X 70	200	12.00
ES10893	BOLT, CAP HEX, M8 X 75	200	12.00
ES10894	WASHER, M8	200	2.00

## METAL ROOF ATTACHMENTS

P/N	DESCRIPTION	PACK SIZE	SHIP WT. LBS
ES10674	STANDING SEAM, STAND 2SS 5/16"	50	24.00
ES10675	STANDING SEAM, KLOC 2SS 5/16"	48	26.00
ES10676	STANDING SEAM, WIDE 2SS 5/16"	48	30.00
ES10918	STANDING SEAM, MINI 2SS 5/16"	48	24.00
ES10919	STANDING SEAM, KLOC MINI 5/16"	48	24.00
ES10830	CORRUBRACKET 100T	60	35.00
ES10875	RIBBRACKET I	75	36.00
ES10877	RIBBRACKET II	75	36.00
ES10879	RIBBRACKET III	75	36.00
ES10881	RIBBRACKET IV	75	36.00
ES11209	PM ADJUST SLOTTED	50	23.00

## METAL ROOF SCREWS

P/N	DESCRIPTION	PACK SIZE	SHIP WT. LBS
ES10831	ROOFING SCREW, METAL TO WOOD, 1.5"	240	12.00
ES10883	ROOFING SCREW, METAL TO METAL, 1.5"	240	12.00

## METAL X MLPE MOUNT & WIRE MANAGEMENT CLIPS

P/N	DESCRIPTION	PACK SIZE	SHIP WT. LBS
008115M	MLPE TIGER CLIP	48	11.00
008003S	ONE WIRE CLIP, SS, DCS 1306	500	3.00
008004S	TWO WIRE CLIP, SS, DCS 1307	500	3.00
008017S	HEYCO SUNRUNNER 2-S CLIP 100/B	500	7.00
008018S	HEYCO SUNRUNNER 4-2U CLIP 100/B	500	6.00
008019S	HEYCO SUNRUNNER CLIP 100/B	100	7.00
008020S	HEYCO SUNRUNNER 4 CLIP 100/B	100	7.00
008021S	SINGLE TRUNK CABLE CLIP	100	7.00
205000S	ENPHASE ENGAGE CABLE CLIP	100	4.00

## METAL X ROW-TO-ROW BONDING

P/N	DESCRIPTION	PACK SIZE	SHIP WT. LBS
ES10201	ECOX BONDING JUMPER 8"	5	1.00
ES10260	ECOX ROW TO ROW BONDING CLIP	800	4.00
ES11108	METALX 30MM ROW BONDING CLIP	10	0.10
008015S	WIRE BND CLIP	10	1.00

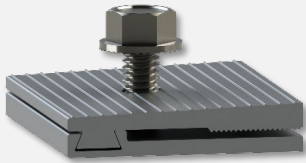

**MLPE TIGER CLIP**

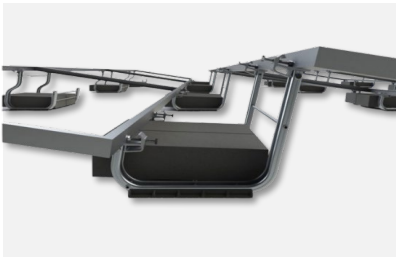

**RM10 EVO FLAT ROOF SYSTEM**

**RM10 EVO BALLAST BAYS, CLAMPS & MID SUPPORT**

P/N	DESCRIPTION	PACK SIZE	SHIP WT. LBS
370010	RM10 EVO FIELD BAY	50	
370010-US	RM10 EVO FIELD BAY (US)	50	
370011	RM10 EVO NORTH BAY	72	
370022	EVO MOD CLAMP SIDE BOLT BULK	100	
370023	EVO MOD CLAMP BULK	100	
370030	EVO MID SUPPORT	20	355.00

**RM10 EVO MLPE MOUNTS, GROUNDING & BONDING HARDWARE**

P/N	DESCRIPTION	PACK SIZE	SHIP WT. LBS
008114M	MLPE MOUNT ASSY	10	1.00
008115M	MLPE TIGER CLIP	48	11.00
205000S	ENPHASE ENGAGE CABLE CLIP	100	4.00
008002S	GROUND WEEBLUG #1	20	2.00
008009P	ILSCO LAY IN LUG	20	2.00

**RM10 EVO ROOF PAD & ATTACHMENT KIT**

P/N	DESCRIPTION	PACK SIZE	SHIP WT. LBS
310760	RM10 EVO ROOF PAD	200	35.00
310771	RM10 EVO ATTACHMENT KIT	1	2.50



**FLASHLOC™ RM**

**FLASHLOC RM FLAT ROOF ATTACHMENT**

FLASHLOC™ RM is a lightweight, durable, powder-coated cast aluminum roof attachment solution that provides fast, easy installation and helps save labor costs. FLASHLOC™ RM is compatible with most roofing materials and is applicable for almost all solar racking form factors. Rigorous mechanical, sealing, and ease-of-install testing has been successfully completed for assurance of long-term reliability.

P/N	DESCRIPTION	PACK SIZE	SHIP WT. LBS
310999	FLASHLOC RM	10	17.00



**GRIDFLEX™ FLAT ROOF SYSTEM**

## GRIDFLEX COMPONENTS

P/N	DESCRIPTION	PACK SIZE	SHIP WT. LBS
360010	GRIDFLEX NORTH RAIL	20	23.00
360020	GRIDFLEX MID RAIL	10	29.00
360030	GRIDFLEX SOUTH RAIL	20	26.00
360042	GRIDFLEX 5D NORTH CLMP ASSY	10	19.50
360050	GRIDFLEX 5D SOUTH CLMP ASSY	20	17.00
360060	GRIDFLEX LANDER PAD	50	18.00
360061	GRIDFLEX HARDWARE KIT	80	5.00
360071	GRIDFLEX BALLAST TRAY, 62-69"	5	32.00
360081	GRIDFLEX BALLAST TRAY, 77-83"	5	36.00
360090	RM GRIDFLEX DEFLECTOR 62-69"	5	23.00
360100	RM GRIDFLEX DEFLECTOR 77-83"	5	28.00
360101	GRIDFLEX BALLAST TRAY, 83-92"	5	35.00
360102	RM GRIDFLEX DEFLECTOR, 83-92"	5	20.00
360110	GRIDFLEX DEFLECTOR 92-100"	5	
360120	GRIDFLEX BALLAST TRAY 92-100"	5	
360200	GRIDFLEX 5D MID SUPPORT	25	



**RM5 FLAT ROOF SYSTEM**



**RM5 CLAMPS**

**RM5 BALLAST BAYS, WIND DEFLECTORS & CLAMP**

P/N	DESCRIPTION	PACK SIZE	SHIP WT. LBS
310800	RM5 BAY	200	1435.00
310803	RM5 BAY, PVC	200	1435.00
310810	RM5 WIND DEFLECTOR, 84"	60	385.00
310811	RM5 WIND DEFLECTOR, 98"	60	460.00
310861	RM5 WIND DEFLECTOR HDW KIT	20	1.00
310820	RM5/DT ENDCLAMP 30-40MM	20	5.50
310821	RM5/DT ENDCLAMP 41-45MM	20	5.50
310822	RM5/DT ENDCLAMP 46-50MM	20	5.50

**RM5 ROOF FRICTION PATCH & ATTACHMENT KIT**

P/N	DESCRIPTION	PACK SIZE	SHIP WT. LBS
310830	RM5/DT PVC ROOF FRICTION PATCH	500	10.00
310882	RM5/DT H-ATTACHMENT KIT	1	6.00

**RM5 WIRE MANAGEMENT CLIPS**

P/N	DESCRIPTION	PACK SIZE	SHIP WT. LBS
310850	RM5/DT WIRE MGMT CLIP	20	1.00
310851	RM5 WD WIRE MGMT CLIP	20	1.00
310860	RM5/DT 1/4-20 CLIP U-NUT SS	20	1.00

**RM5 MLPE MOUNTS, GROUNDING & BONDING HARDWARE**

P/N	DESCRIPTION	PACK SIZE	SHIP WT. LBS
008114M	MLPE MOUNT ASSY	10	1.00
008115M	MLPE TIGER CLIP	48	11.00
205000S	ENPHASE ENGAGE CABLE CLIP	100	4.00
008002S	GROUND WEEBLUG #1	20	2.00
008009P	ILSCO LAY IN LUG	20	2.00



**FLASHLOC™ RM**

**FLASHLOC RM FLAT ROOF ATTACHMENT**

FLASHLOC™ RM is a lightweight, durable, powder-coated cast aluminum roof attachment solution that provides fast, easy installation and helps save labor costs. FLASHLOC™ RM is compatible with most roofing materials and is applicable for almost all solar racking form factors. Rigorous mechanical, sealing, and ease-of-install testing has been successfully completed for assurance of long-term reliability.

P/N	DESCRIPTION	PACK SIZE	SHIP WT. LBS
310999	FLASHLOC RM	10	17.00



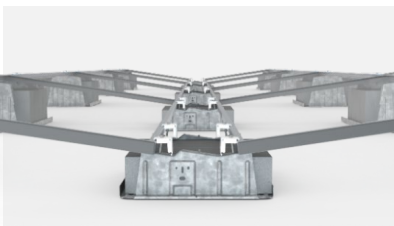

**RMDT FLAT ROOF SYSTEM**

### RMDT BALLAST BAYS & CLAMPS

P/N	DESCRIPTION	PACK SIZE	SHIP WT. LBS
310801	RMDT RIDGE BAY	150	1575.00
310802	RMDT VALLEY BAY	200	1125.00
310804	RMDT RIDGE BAY, PVC	150	1575.00
310805	RMDT VALLEY BAY, PVC	200	1125.00
310820	RM5/DT ENDCLAMP 30-40MM	20	5.50
310821	RM5/DT ENDCLAMP 41-45MM	20	5.50
310822	RM5/DT ENDCLAMP 46-50MM	20	5.50
310823	RMDT MIDCLAMP 46-50MM	20	5.50
310824	RMDT MIDCLAMP 41-45MM	20	5.50
310825	RMDT MIDCLAMP 36-40MM	20	5.50
310826	RMDT MIDCLAMP 32-35MM	20	5.50

### RMDT ROOF FRICTION PATCH & ATTACHMENT KIT

P/N	DESCRIPTION	PACK SIZE	SHIP WT. LBS
310830	RM5/DT PVC ROOF FRICTION PATCH	500	10.00
310882	RM5/DT H-ATTACHMENT KIT	1	6.00

### RMDT WIRE MANAGEMENT CLIPS

P/N	DESCRIPTION	PACK SIZE	SHIP WT. LBS
310850	RM5/DT WIRE MGMT CLIP	20	1.00
310851	RM5 WD WIRE MGMT CLIP	20	1.00
310860	RM5/DT 1/4-20 CLIP U-NUT SS	20	1.00

### RMDT MLPE MOUNTS, GROUNDING & BONDING HARDWARE

P/N	DESCRIPTION	PACK SIZE	SHIP WT. LBS
008114M	MLPE MOUNT ASSY	10	1.00
008115M	MLPE TIGER CLIP	48	11.00
205000S	ENPHASE ENGAGE CABLE CLIP	100	4.00
008002S	GROUND WEEBLUG #1	20	2.00
008009P	ILSCO LAY IN LUG	20	2.00



**FLASHLOC™ RM**

### FLASHLOC RM FLAT ROOF ATTACHMENT

FLASHLOC™ RM is a lightweight, durable, powder-coated cast aluminum roof attachment solution that provides fast, easy installation and helps save labor costs. FLASHLOC™ RM is compatible with most roofing materials and is applicable for almost all solar racking form factors. Rigorous mechanical, sealing, and ease-of-install testing has been successfully completed for assurance of long-term reliability.

P/N	DESCRIPTION	PACK SIZE	SHIP WT. LBS
310999	FLASHLOC RM	10	17.00



**ECOFOOT2+ FLAT ROOF SYSTEM**



**ECOFOOT2+ BASE**

**ECOFOOT2+ BASE, MID SUPPORT, WIND DEFLECTORS & CLAMPS**

P/N	DESCRIPTION	PACK SIZE	SHIP WT. LBS
ES20142	ECOFOOT2+ BASE W/ EPDM STRIPS	300	1285.00
ES20207	ECOFOOT2+ BASE	300	1226.00
ES11203	ECOFOOT2+ MID-SUPPORT KIT	48	33.00
ES20311A	ECOFOOT2+ 44" WIND DEFLECTOR	300	1525.00
ES20311B	ECOFOOT2+ 70" WIND DEFLECTOR	300	1776.00
ES20311C	ECOFOOT2+ 82" WIND DEFLECTOR	300	2014.00
ES20311H	ECOFOOT2+ 86" WIND DEFLECTOR	300	2094.00
ES20311I	ECOFOOT2+ 55" WIND DEFLECTOR	300	
ES20311K	ECOFOOT2+ 92" WIND DEFLECTOR	300	2260.00
ES10466	ECOFOOT UNIVERSAL CLAMP KIT	48	51.00
ES20501	B22 GALVANIZED STRUT 10'	1	16.10

**ECOFOOT2+ WIRE MANAGEMENT, MLPE MOUNTS, ACCESSORIES & BONDING HARDWARE**

P/N	DESCRIPTION	PACK SIZE	SHIP WT. LBS
008017S	HEYCO SUNRUNNER 2-S CLIP 100/B	500	7.00
008018S	HEYCO SUNRUNNER 4-2U CLIP 100/B	500	6.00
008019S	HEYCO SUNRUNNER CLIP 100/B	100	7.00
008020S	HEYCO SUNRUNNER 4 CLIP 100/B	100	7.00
008021S	SINGLE TRUNK CABLE CLIP	100	7.00
ES10810	ECOTRAY BASE, 6"	10	2.90
ES10811	ECOTRAY CAP 96"	10	3.90
ES10812	ECOTRAY TRAY, 96"	10	4.70
ES10813	ECOTRAY RIVET	100	4.00
ES20913	ECOMOUNT 1 INVERTER KIT	1	31.00
ES20914	ECOMOUNT 2 INVERTER KIT	1	53.00
ES10378	ECOFOOT BONDING JUMPER 38"	5	0.35
ES10970	ECOFOOT MLPE BRACKET	48	19.00
008114M	MLPE MOUNT ASSY	10	1.00
008115M	MLPE TIGER CLIP	48	11.00

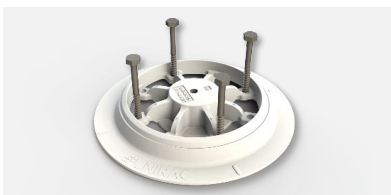

**FLASHLOC™ RM**

**FLASHLOC RM FLAT ROOF ATTACHMENT**

FLASHLOC™ RM is a lightweight, durable, powder-coated cast aluminum roof attachment solution that provides fast, easy installation and helps save labor costs. FLASHLOC™ RM is compatible with most roofing materials and is applicable for almost all solar racking form factors. Rigorous mechanical, sealing, and ease-of-install testing has been successfully completed for assurance of long-term reliability.

P/N	DESCRIPTION	PACK SIZE	SHIP WT. LBS
310999	FLASHLOC RM	10	17.00



**ECOFOOT5D BASE**

**ECOFOOT5D BASE, MID SUPPORT, WIND DEFLECTORS & CLAMPS**

P/N	DESCRIPTION	PACK SIZE	SHIP WT. LBS
ES10490	ECOFOOT5D BASE	340	1945.00
ES10480	ECOFOOT5D MID-SUPPORT KIT	24	25.00
ES10486	ECOFOOT5D 71" BALLAST TRAY	250	2013.00
ES10488	ECOFOOT5D 83" BALLAST TRAY	250	2346.00
ES11023	ECOFOOT5D 87" BALLAST TRAY	250	2475.00
ES11025	ECOFOOT5D 93.25" BALLAST TRAY	250	
ES10494	ECOFOOT5D 70" WIND DEFLECTOR	100	2027.00
ES10496	ECOFOOT5D 82" WIND DEFLECTOR	100	2391.00
ES11024	ECOFOOT5D 86" WIND DEFLECTOR	100	2515.00
ES11026	ECOFOOT5D 92.25" WIND DEFLECTOR	800	
ES10843	ECOFOOT ROOF TO STRUT HDWR KIT	24	17.00
ES10844	ECOFOOT STRUT TO MOD HDWR KIT	24	12.00
ES10851	ECOFOOT STRUT TO MOD KIT 30MM	24	11.00
ES10466	ECOFOOT UNIVERSAL CLAMP KIT	48	51.00
ES20501	B22 GALVANIZED STRUT 10'	1	16.10

**ECOFOOT5D WIRE MANAGEMENT, MLPE MOUNTS, ACCESSORIES & BONDING HARDWARE**

P/N	DESCRIPTION	PACK SIZE	SHIP WT. LBS
008017S	HEYCO SUNRUNNER 2-S CLIP 100/B	500	7.00
008018S	HEYCO SUNRUNNER 4-2U CLIP 100/B	500	6.00
008019S	HEYCO SUNRUNNER CLIP 100/B	100	7.00
008020S	HEYCO SUNRUNNER 4 CLIP 100/B	100	7.00
008021S	SINGLE TRUNK CABLE CLIP	100	7.00
ES10810	ECOTRAY BASE, 6"	10	2.90
ES10811	ECOTRAY CAP 96"	10	3.90
ES10812	ECOTRAY TRAY, 96"	10	4.70
ES10813	ECOTRAY RIVET	100	4.00
ES20913	ECOMOUNT 1 INVERTER KIT	1	31.00
ES20914	ECOMOUNT 2 INVERTER KIT	1	53.00
ES10378	ECOFOOT BONDING JUMPER 38"	5	0.35
ES10970	ECOFOOT MLPE BRACKET	48	19.00
008114M	MLPE MOUNT ASSY	10	1.00
008115M	MLPE TIGER CLIP	48	11.00

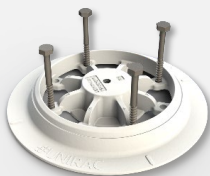

**FLASHLOC™ RM**

**FLASHLOC RM FLAT ROOF ATTACHMENT**

FLASHLOC™ RM is a lightweight, durable, powder-coated cast aluminum roof attachment solution that provides fast, easy installation and helps save labor costs. FLASHLOC™ RM is compatible with most roofing materials and is applicable for almost all solar racking form factors. Rigorous mechanical, sealing, and ease-of-install testing has been successfully completed for assurance of long-term reliability.

P/N	DESCRIPTION	PACK SIZE	SHIP WT. LBS
310999	FLASHLOC RM	10	17.00



**GROUND FIXED TILT (GFT)**

## GFT C-PILES

P/N	DESCRIPTION	PACK SIZE	SHIP WT. LBS
404001	GFT C-PILE, 12.5'	30	2400.00
404002	GFT C-PILE, 15'	30	2910.00
404004	GFT C-PILE, 10.5'	30	2016.00

## GFT TOP CHORDS & BRACES FOR SHARED RAIL DESIGNS

P/N	DESCRIPTION	PACK SIZE	SHIP WT. LBS
404036	GFT TOP CHORD CHANNEL 20/30 LS	30	1080.00
404031	GFT DIAGONAL BRACE ASSEMBLY 20D SR	30	630.00
404032	GFT DIAGONAL BRACE ASSEMBLY 30D SR	30	750.00
404034	GFT ASSEMBLY HARDWARE 3-RAIL KIT	30	90.00
404013	GFT ASSEMBLY HARDWARE 4-RAIL KIT	30	90.00

## GFT RAIL & SPLICE

P/N	DESCRIPTION	PACK SIZE	SHIP WT. LBS
411168M	GFT RAIL 168" MILL	60	850.00
411246M	GFT RAIL 246" MILL	60	1200.00
404014	GFT RAIL SPLICE KIT	60	180.00

## GFT WIRE MANAGEMENT CLIPS & ACCESSORIES

P/N	DESCRIPTION	PACK SIZE	SHIP WT. LBS
404015	GFT WIRE MANAGEMENT CLIP	100	5.00
404020	GFT RAIL SUPPLEMENTAL HDWR 4-RAIL	1	3.00
GFT-CAP	GFT RAIL END CAP, UV-BLK	100	3.30

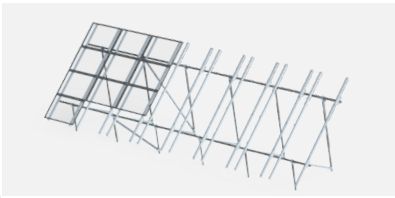

### ULA COMPONENTS FOR 2-INCH SCHEDULE 40/80 PIPE

P/N	DESCRIPTION	PACK SIZE	SHIP WT. LBS
403200C	ULA BRACE, 2"@ 7 FT,	1	10.00
403201C	ULA BRACE, 2"@ 10.5 FT,	1	16.00
403202C	ULA BRACE, 2"@ 14 FT,	1	21.00
403211C	ULA FRONT CAP, 2", AL	1	2.00
403214C	ULA REAR CAP, 2", AL	1	2.00
403215C	ULA SLIDER, 2", AL	1	1.00
403216M	ULA RAIL BRACKET	1	

### ULA ATTACHMENT FOR CONCRETE SLAB OR FOOTING

P/N	DESCRIPTION	PACK SIZE	SHIP WT. LBS
403216S	ULA THREADED FOOT, 2", STL	1	2.00

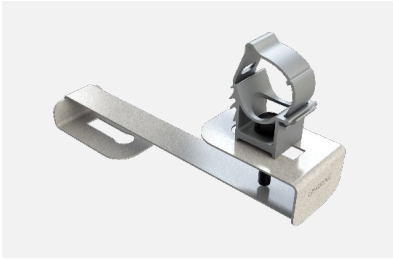

**E-BOSS TILE CONDUIT MOUNT**

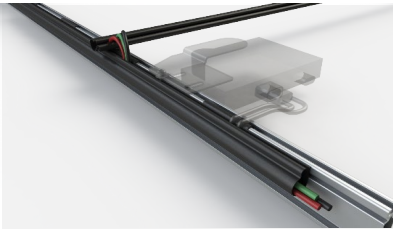

**E-BOSS WIRE MANAGEMENT**

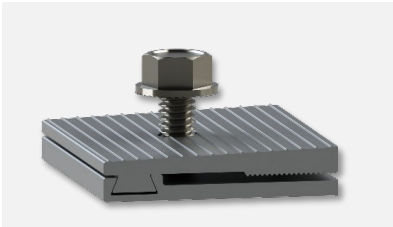

**MLPE TIGER CLIP**

### E-BOSS CONDUIT MOUNTS

P/N	DESCRIPTION	PACK SIZE	SHIP WT. LBS
00822CM	E-BOSS CONDUIT MT 2.0 COMP KIT	10	5.00
00823CM	E-BOSS TILE CONDUIT MT KIT	10	

### E-BOSS SOLARTRAY WIRE MANAGEMENT

P/N	DESCRIPTION	PACK SIZE	SHIP WT. LBS
00802RT	E-BOSS RAIL TRAY	40	18.00
00802BT	E-BOSS BRIDGE TRAY	20	11.00
00802BC	E-BOSS BRIDGE CLIPS	200	2.00

### SOLOBOX JUNCTION BOX

P/N	DESCRIPTION	PACK SIZE	SHIP WT. LBS
SOLOBOX	SOLOBOX JUNCTION BOX	8	5.00
SOLOBOX-D	SOLOBOX JUNCTION BOX w/ DIN RL	8	5.00
00802JB	E-BOSS J-BOX MOUNTING BRACKET	20	15.00

### MLPE MOUNTS

P/N	DESCRIPTION	PACK SIZE	SHIP WT. LBS
008114M	MLPE MOUNT ASSY	10	1.00
008115M	MLPE TIGER CLIP	48	11.00